

**INSTRUCTION AND MAINTENANCE BOOKLET**

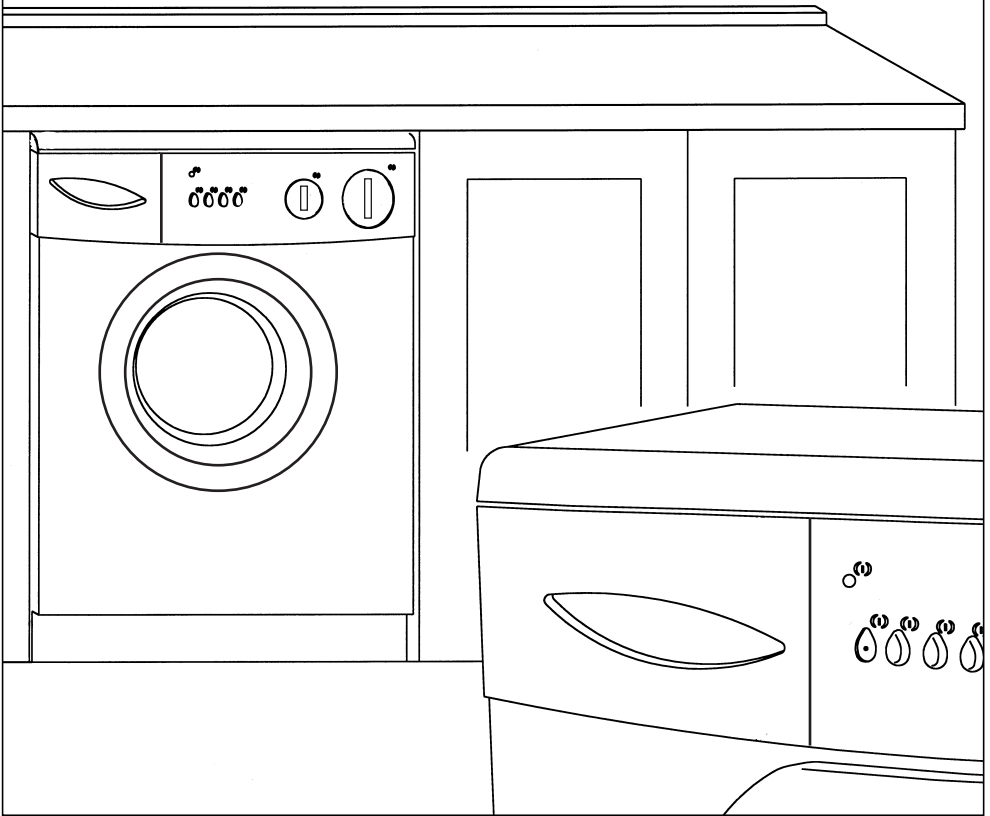

Instruction and  
maintenance  
booklet

**Contents**

Getting to know your washing machine..... 28

Preliminary warnings..... 28

Description of your washing machine..... 28

Using the selector controls ..... 28

    Programme selector control ..... 28

    Temperature selector control ..... 28

    Spin speed selector dial ..... 29

Stop/start button ..... 29

Additional function buttons ..... 29

Loading the machine ..... 29

Adding detergent and additives ..... 30

Selecting the wash programme ..... 31

Programme tables..... 31

Programme guide ..... 32 / 33

Cleaning your washing machine before use..... 34

Cleaning and special care ..... 34

Starting your machine ..... 34

End of programme..... 34

Practical advice for a better wash..... 35

Sorting the clothes ..... 35

Care label symbols..... 35

Treating stains..... 36

Practical advice on the wash load..... 36

General hints on washing..... 36

General tips ..... 37

Troubleshooting guide ..... 37

## Getting to know your washing machine

Before doing anything else you should get to know your washing machine perfectly. To help you recognise all the different devices and elements which your machine is equipped with, we have included some diagrams. These can be found at the back of the BOOKLET, inside the back cover.

Please study them carefully. They will help you to understand the text and to visually locate all the elements which make up your machine.

## Preliminary warnings

### Installation

It is essential that the installation of your WASHING MACHINE be carried out in accordance with current standards.

Specific installation instructions can be found in the INSTALLATION MANUAL.

Before starting your washing machine, it is absolutely essential to remove the INTERNAL FIXING SCREWS, used for transit. To do this, consult the installation manual.

### Technical specifications table

Stuck to the back of your WASHING MACHINE, you will find a TECHNICAL SPECIFICATIONS TABLE, which gives the technical and identification information for your machine. THIS LABEL SHOULD BE CONSULTED BEFORE MAKING ANY ELECTRICAL CONNECTIONS.

In order to preserve the environment, your washing machine is equipped with a system which is capable of adapting to different conditions of use (amount of clothes and type of fabric), thereby ensuring an optimum level of water and power with the same wash and rinse results. This means that during the washing process, the amount of water you observe through the hatch may seem low.

Moreover, for the same reason, some models have a patented system by means of which the drum turns faster than normal for a short amount of time (2 seconds) only in the wash programmes for normal fabrics (cotton, linen, etc.). This occurs between six and eight times during the whole wash.

## Description of your washing machine

(Figure 1)

- 1.- Top.
- 2.- Loading door.
- 3.- Handle.
- 4.- Exterior door (depending on model).
- 5.- Plinth (depending on model).

### Control panel (Figure 2)

- 6.- Programme selector control knob.
- 7.- Wash temperature selector control knob.
- 8.- Additional function buttons.
- 9.- Detergent dispenser.
- 10.- «ON» light.
- 11.- Spin speed selector dial.

## Using the selector controls

### Programme selector control



You can use this control to select the Wash Programme you require. Turn the control knob clockwise. Until the indicator coincides with the number of the programme required. NEVER TRY TO FORCE THE KNOB in the opposite direction.

### Temperature selector control



Use this control to select the wash temperature you require. Turn it gently until the number corresponding to the temperature required coincides with the indicator.

## ENGLISH

If you want to wash with cold water, turn the knob until the cold symbol  coincides with the indicator.

### Spin speed selector dial

With this dial, you can choose the spin speed. To do this turn dial until the speed printed on the dial coincides with the printed sign on the machine.



### Stop/start button

Once you have selected programme you require, press this button to start your washing machine. The «ON» light will come on after a few seconds, during which time the door. Safety device is activated.

If the programme is completed without interruptions, you can open the loading door once the programme is over and you have waited for the door locking safety device to be deactivated (about 2 minutes). The «ON» light will go off indicate this.

When your washing machine is in operation, the wash cycle can be interrupted by pressing the stop/start button. The «ON» light will go off. Press the stop/start button again, to start your washing machine from the phase of the cycle where it left off. If you stop your machine to add or remove garments, make sure that the water level is not so high that it could overflow when the door is opened. Also make sure that the temperature inside the drum is not too high. Remember that even though the «ON» light goes off, you have to wait about two minutes until the door safety device is deactivated before you can open the door.

### Additional function buttons

By pressing these buttons you can include a series of additional functions and features in the wash programme you have selected. These functions and features will enable you to adjust the wash to your particular needs and requirements.

Depending on the model, your washing machine will have some of the following functions.

### No spin button

Press this button to eliminate the spin phase from any programme selected. This will help to avoid creasing when washing special fabrics.



### Spin selector button

Press this button to reduce spin speed. This function is specially recommended for washing clothes which are very worn or have a special finish.



### Creaseguard button

Press this button to interrupt the last rinse and hold the clothes immersed in water inside the drum to avoid creasing. Press the button again to complete the programme. Or select the drain-only programme to avoid the spin cycle.



### Extra rinse button

Press this button to increase the final rinse. This increases water consumption.



### Cold wash button

Press this button to select a cold wash programme.



### Load button

In the models which do not have the automatic variable capacity feature, press this button to save water by reducing consumption when washing small loads.



## Loading the machine

### Opening the door

In order to open the door, pull outwards on the handle (Figure 1-3)

### Loading the drum

When loading clothes into the drum, you should bear the following points in mind:

- Make sure all the pockets are empty.
- Stretch out and unfold each item.

- Put the items into the drum one by one, so that they do not get tangled up together.
- Take into account the recommended load size for each programme.
- When washing towels, try not to wash them on their own. Mix them in with other clothes.

Once you have loaded the drum, close the door by pressing on it until it is properly closed. Make sure that no clothes get trapped between the door and the rubber seal.

## Adding detergent and additives

Before starting the wash programme, add the detergent or additive to the detergent dispenser (Figure 3).

Depending on the model, the detergent dispenser in your washing machine has three or four compartments marked with the following symbols.



**compartment:**

For the PREWASH detergent.



**compartment:**

For the MAIN WASH detergent.



**compartment:**

For additives like starch, fabric conditioner, etc., if required.



**compartment:**

(Optional) For liquid whiteners: bleach, etc., if required.

**Note:** The level of liquid should never exceed the MAX LEVEL (Figure 3).

### Optional dispenser

You can also use liquid detergent in your washing machine. To do this you need the optional dispenser which you can obtain

through the FAGOR SERVICE NETWORK. This optional dispenser should be placed in the COMPARTMENT of the detergent dispenser (Figure 3-A). Always use the amount recommended by the detergent manufacturer. However, the detergent should never go above the MAX level marked on the side of the dispenser.

## Detergent

Only use detergents suitable for automatic washing machines good quality detergents which do not produce too much lather. When washing woollen garments, only use neutral detergents.

## Detergent guide

Remember that the amount of detergent to be used always depends on:

- The size of the load.
- The type of clothes to be washed.
- How dirty the clothes are.
- The hardness of the water.

Using more detergent than necessary will not improve the results of your wash. In addition to being a waste it will also have negative effects on the environment.

For wash programmes without a prewash, it is best to use detergents which can be put straight in the drum. In any case, we recommend that you follow the instructions of the manufacturer of the detergent used.

The following table will help you to determine the amount of detergent to be used, depending on the hardness of the water and the size of the load.

## ENGLISH

	LOAD SIZE IN KG.			
	4,5	3,5	2	1 kg.
Water Hardness (French measures)	Amount of detergent in grammes			
Soft: (Up to 12)	90	80	65	55
Medium: (12/25)	125	115	90	75
Hard (25/37)	160	140	110	90
Very hard (25/37)	180	160	130	110
Information about water hardness can be obtained from your local authority. If your water hardness is measured in german measures, divide the hardness values given above by 1.78.				

### Selecting the wash programme

Your washing machine offers you a wide range of programmes which will enable you to wash all types of clothing.

It has 2 types of PROGRAMME:

- 1.- NORMAL WASH PROGRAMMES, for resistant fabrics.
- 2.- DELICATE WASH PROGRAMMES, for delicate fabrics.

The wash systems included in your washing machine are ideal for washing both cotton and synthetic garments, as well as woollen, silk or acrylic garments.

Basically, what varies between PROGRAMMES is the drum rotation speed, temperature, wash time and water level.

In general, the NORMAL cycles are best for washing resistant fabrics like cotton, resistant synthetics, linen, etc., whilst the DELICATE cycles, with slower drum rota-

tion speeds, lower temperature and higher water levels, are for synthetic fabrics, wool, silk, etc.

The models which have the wash temperature selector control have an automatic variable load control feature, which automatically adjusts the consumption of water and electricity to the a quantity of clothes to be washed.

### Programme tables

There follows a number of detailed PROGRAMME TABLES. Please consult them, as they will provide you with information about the different wash programmes which your washing machine offers.















An abbreviated version of the table can be found on the front or top panel of the detergent dispenser, or on a card included in the documentation bag.

## Guide for washing machines with 10 programmes

### Normal wash programmes:











Fabrics of cotton, linen, carvas, etc.

Maximum recommended load: see reference plates

Program setting	PROGRAMME DESCRIPTION	Range of recommend. temperatures	Wash product compartments	Clothes symbols	Degree of dirtiness whites / coloureds	Estimated duration	
1	Prewash, followed by wash, rinsing, automatic absorption of additives if required and final spin.	90-70° C	 		Very dirty. White.	115-135 minutes	
		60-50° C				Very dirty. Resistant colours.	125-135 minutes
		40-Cold			 	Very dirty. Delicate colours.	110-120 minutes
2 (*)	Wash, rinsing, automatic absorption of additives if required and final spin.	90-70° C	 		Dirty. White.	100-120 minutes	
		60-50° C				Dirty. Resistant colours.	110-120 minutes
		40-Cold			 	Slightly soiled. Delicate colours.	95-100 minutes
3	Rinse with automatic absorption of additives if required and final spin.		 		Resistant fabrics.	40 minutes	
4	Draining and long spin.				Resistant fabrics.	8 minutes	

### Delicate wash programmes:





Delicate synthetic fabrics, mixed fabrics, etc. Maximum recommended load: 2,5/3 kg. (half of the maximum washing machine load)

Program setting	PROGRAMME DESCRIPTION	Range of recommend. temperatures	Wash product compartments	Clothes symbols	Degree of dirtiness whites / coloureds	Estimated duration
5	Wash, rinsing, automatic absorption of additives if required and final spin.	60-50° C	 		Dirty. White.	55-60 minutes
		40-Cold			 	Slightly soiled. Delicate colours.
6	Short wash, rinsing, automatic absorption of additives if required and final spin.	40-Cold	 	 	Slightly soiled. Delicate colours.	40-45 minutes
7	Rinse with automatic absorption of additives if required and final spin.				Delicate fabrics.	10 minutes
8	Draining and gentle spin.				Delicate fabrics.	6 minutes

### Wool wash programme:

Wool Fabrics

Maximum recommended load: 1,0 kg.

Program setting	PROGRAMME DESCRIPTION	Range of recommend. temperatures	Wash product compartments	Clothes symbols	Degree of dirtiness whites / coloureds	Estimated duration
9	Wash, rinsing, automatic absorption of additives if required and draining.	40-Cold	 	 	Slightly soiled. Delicate colours.	40-50 minutes
10	Draining without spin.					5 minutes















## Guide for washing machines with 13 programmes

### Normal wash programmes:

Fabrics of cotton, linen, canvas, etc.











Maximum recommended load: see reference plates

Program. setting	PROGRAMME DESCRIPTION	Range of recommend. temperatures	Wash product compartments	Clothes symbols	Degree of dirtiness whites / coloureds	Estimated duration
1	Prewash, followed by wash, rinsing, automatic absorption of additives if required and final spin.	90-70° C	 		Very dirty. White.	125 minutes
		60-50° C			Very dirty. Resistant colours.	
		40-Cold		 	Very dirty. Delicate colours.	
2	Wash, rinsing, automatic absorption of additives if required and final spin.	90-70° C	 		Dirty. White.	100 minutes
60-50° C				Dirty. Resistant colours.	85 minutes	
4		40-Cold		 	Slightly soiled. Delicate colours.	70 minutes
5	Rinse with automatic absorption of additives if required and final spin.				Resistant fabric garments.	30 minutes
6	Draining and long spin.				Resistant fabric garments.	5 minutes

### Delicate wash programmes:

Delicate synthetic fabrics, mixed fabrics,





Maximum recommended load: 2,5/3 kg. (half of the maximum washing machine load)

Program. setting	PROGRAMME DESCRIPTION	Range of recommend. temperatures	Wash product compartments	Clothes symbols	Degree of dirtiness whites / coloureds	Estimated duration
7	Wash, rinsing, automatic absorption of additives if required and final spin.	60-50° C	 		Dirty. White.	70 minutes
8		40-Cold		 	Slightly soiled. Delicate colours.	50 minutes
10	Short wash, rinsing, automatic absorption of additives if required and final spin.	40-Cold	 	 	Slightly soiled. Delicate colours.	40 minutes
11	Rinse with automatic absorption of additives if required and final spin.				Delicate fabrics.	10 minutes
12	Draining and gentle spin.				Delicate fabrics.	5 minutes

### Wool wash programme:

Wool Fabrics

Maximum recommended load: 1,0 kg.

Program. setting	PROGRAMME DESCRIPTION	Range of recommend. temperatures	Wash product compartments	Clothes symbols	Degree of dirtiness whites / coloureds	Estimated duration
9	Wash, rinsing, automatic absorption of additives if required and draining.	40-Cold	 	 	Slightly soiled. Delicate colours.	45 minutes
13	Draining without spin.					3 minutes

(\*) Energy label data based on this programme, in accordance with EN60456.

## Cleaning your washing machine before

It is advisable to clean the inside of your washing machine before using it for the first time, in order to get rid of any lubricants or water left over from testing. To do this you should:

- Put a measure of detergent into the  COMPARTMENT of the DETERGENT DISPENSER.
- Select WASH PROGRAMME «2» (90° without prewash) with the programme selector control knob.
- Start the washing machine.
- Wait until the PROGRAMME finishes.

## Cleaning and special care (Fig. 6)

Clean the accessible filter whenever the drainage pump is blocked by foreign bodies.

- a) Loosen the base by gently pulling on the sides and turning downwards. Then undo the fasteners.  
If there is no side access, introduce a small screwdriver in the three slots on the upper part of the base, in order to lever it and loosen the hooks.
- b) Use a plate or other container under the filter to collect the water that will be released when it is loosened.
- c) Turn the filter a quarter- or halfway sideways towards the left. Water will start to come out.
- d) When you are finished taking the water out of the washing machine, turn the filter around several times until you can take it out fully.
- e) Remove any objects or fluff that may be in the filter.
- f) Replace the filter and the base in their places.

**Important:** In order to avoid burns, this operation should not be carried out when the wash water temperature is over 30°C.

## Starting your machine

When starting your washing machine, carefully follow all the steps explained below:

- 1.- Check that the washing machine is plugged in and that the power is turned on.
- 2.- Turn on the tap or open the stopcock.
- 3.- Put the clothes into the DRUM.
- 4.- Close the LOADING DOOR properly.
- 5.- Put the required amount of detergent into the DETERGENT DISPENSER.
- 6.- Select the PROGRAMME you require with the PROGRAMME SELECTOR control knob.
- 7.- Select the wash temperature with the TEMPERATURE SELECTOR control knob.
- 8.- Select the required spin speed with the SPIN SPEED SELECTOR DIAL.
- 9.- Select any special functions you require by pressing the corresponding buttons.
- 10.- Press the STOP/START button. The «ON» light will come on. The wash programme selected will now begin.

## End of programme

When the programme selector control knob reaches the STOP POSITION, this means that the programme has finished.

DO NOT OPEN THE DOOR OF YOUR WASHING MACHINE UNTIL THE DOOR SAFETY DEVICE IS DEACTIVATED.

Press the STOP/STAR button.

## Practical advice for a better wash

There follows some advice, which you should bear in mind when using your washing machine. Advice concerning the different types of clothes you can wash and the different types of detergent you can use.

Please read these pages carefully as they will help you to get the best results from your machine and to maintain it properly.

## Sorting the clothes

Sort the different articles of clothing according to:

- COLOUR.
- DIRTINESS.
- SENSITIVITY.

### Colour

- Before putting the clothes into the machine, sort the clothes according to the type of fabric and depth of colour.
- Wash whites separately from coloureds.
- If your coloureds are new, it is best to wash them separately the first few times.

### Dirtiness

- Sort the clothes according to dirtiness. Give special treatment to those which are very dirty or have got difficult stains.
- Treat very dirty areas, like collars and cuffs, beforehand.
- Wash clothes that are only slightly dirty in short programmes. In this way, you will save energy as well as getting excellent results.
- Wash averagely dirty clothes in a normal wash programme.

- Wash very dirty clothes in a long programme with a prewash.

### Sensitivity

- Certain clothes, either because of their fabric or the way they are made, may be sensitive to action of your machine. When washing them it is best to use DELICATE PROGRAMMES.
- You can wash woollen garments in the SPECIAL WOOL PROGRAMME. Make sure, first of all, that your woollen garments are machine washable.









## Care label symbols

These symbols are normally found on the care labels in the necks or side seams of your clothes. They indicate:

- Maximum WASH temperature.
- Type of wash they can withstand.
- Products with which they can or cannot be washed.
- Treatments for their care.
- Correct ironing temperature and method.

### Care label symbols

-  For washing at 30° C.
-  For washing at 40° C.
-  For washing at 60° C. Coloureds.
-  For washing at 90° C. Resistant fabrics.
-  Do not wash at home.
-  For bleaching.
-  For bleaching.
-  Do not bleach.
-  For dry cleaning.
-  Do not dry clean.
-  For drying.
-  Do not dry.

-  For dry cleaning and special treatments.
-  For dry cleaning. Use only mineral solvents: benzine, white spirit, etc.
-  For dry cleaning. Perchlorethylene may be used in addition to the previous solvents.
-  For dry cleaning. All normal solvents can be used.
-  Cool iron.
-  Warm iron.
-  Hot iron.
-  Do not iron at home.
-  Wool.

## Treating stains

On many occasions, due to the type and characteristics of some stains, you may not be able to get the results you would like from the wash. There follows a guide to the special treatments you can apply to these stains before putting the clothes into your washing machine.

### Water soluble stains

Treat these stains, even if they are stubborn, with concentrated detergent or washing soap.

### Stains not soluble in water

Treat these stains with a special stain removal product.

### Difficult stains

Felt-tip pen and biro: rub these stains with a cloth soaked in alcohol.

Candle wax: cover these stains with a piece of blotting-paper and iron at the correct temperature for the material. If necessary, repeat the operation.

Resin, grease and skin-care cream: treat these stains with a petrol-based stain remover and then wash.

Tar: rub these stains with butter and set to one side for a while, then wash.

Blood, milk and egg: soak in cold water and then wash with biological detergent at a

temperature of 50° to 60°, provided the fabric can take it.

Fruit, coffee and wine: these stains normally disappear after a number of washes.

If you come up against a stain which is not washable or particularly stubborn, ask for specialist advice. In any case, NEVER USE CHEMICAL PRODUCTS IN THIS WASHING MACHINE.

## Practical advice on the wash load

- Whenever possible, it is best to wash with a full load, as this will reduce water and electricity consumption considerably.
- If you have to wash very dirty clothes or very absorbent items (towels, bathroom linen, etc.), it is advisable to reduce the maximum load given.
- Whenever possible, we recommend that you wash items of different sizes in the same wash programmes, as this helps the wash action and benefits the distribution of clothes in the drum during spin drying. It also means that the machine operates more quietly.

## General hints on washing

- When you wash garments which require different wash temperatures, always select the lowest temperature.
- Generally speaking, whiteners should only be used to wash resistant white fabrics such as cotton, linen, etc.
- Wash garments made of synthetic, mixed and delicate fibres in delicate programmes to avoid creasing which will be difficult to iron out.
- It is best to finish delicate programmes with a short spin. This will increase the efficiency of the rinses and mean that the clothes are well wrung out.

## General tips

### Maintenance

Before cleaning or carrying out any maintenance operation on your washing machine, always unplug it from the mains supply.

### Cleaning

After each wash, leave the loading door open for a while so that air can circulate inside your machine.

From time to time it is a good idea to run a complete wash cycle, using a descaling product. This will help prolong the life of your machine.

### Cleaning the outside of your washing machine

Use warm soapy water or a gentle nonabrasive cleaning agent which is not a solvent to clean the outside of your washing machine. Then dry it well with a soft cloth.

### Cleaning the detergent dispenser

Clean the detergent dispenser whenever you see a build up of washing powder deposits. To do this:

- Take the DETERGENT DISPENSER right out, pulling outwards the handle.
- Clean the DISPENSER COMPARTMENTS with warm water and a brush.
- Clean the SUCTION SYPHONS as well.

Once you have done this, put the dispenser back in your washing machine.

## Troubleshooting guide

If you have problem with your washing machine, you will probably be able to solve it by consulting the following guide.

If the guide does not offer a solution to the problem, unplug your washing machine and call your nearest AUTHORISED SERVICE CENTRE. Your washing machine contains no fuses or similar components which you can change. NEVER tamper with your washing machine.

### Your washing machine does not start

Possible causes

- There is no electricity supply.
- Your washing machine is not plugged in.
- A mains fuse has blown.
- Your washing machine door is not properly shut.
- The STOP/START button has not been pressed.

### Your washing machine is not taking in water

Possible causes

- The mains water supply has been cut off.
- The water inlet tap is turned off.
- The hose filter is blocked.
- The pipe is blocked or bent.

### Your washing machine does not empty or spin

Possible causes

- The water outlet pipe is blocked or bent.

### Your washing machine vibrates or makes a lot of noise.

Possible causes

- The INTERNAL FIXING SCREWS have not been removed. (Consult the installation manual).
- The washing machine has not been properly levelled.

### Important

All models have a spin safety system which stops the spin function from working if the clothes are not properly distributed in such a way that they could cause excessive vibrations. If your clothes should come out very wet, spin dry them again ensuring that they are evenly distributed in the drum.



Figura 2





Figura 3

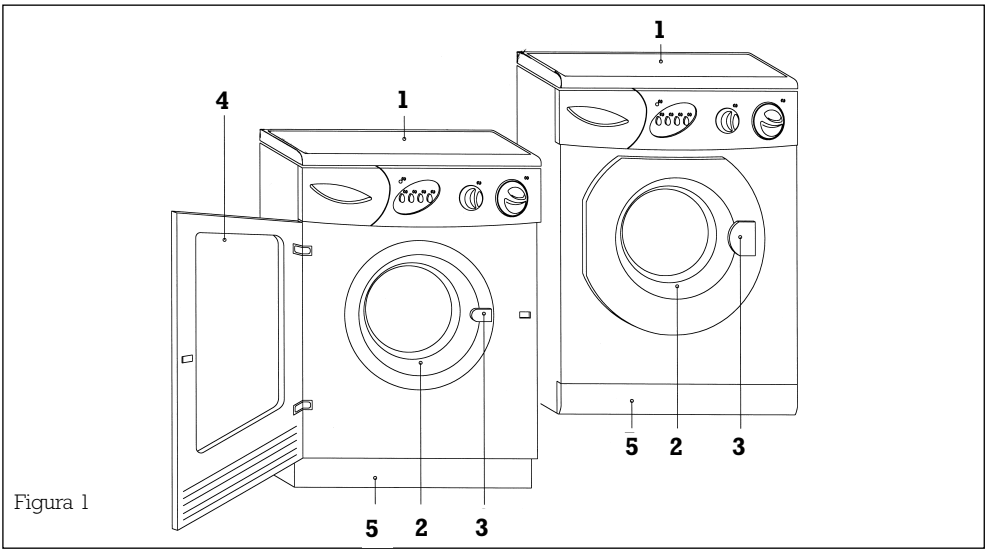
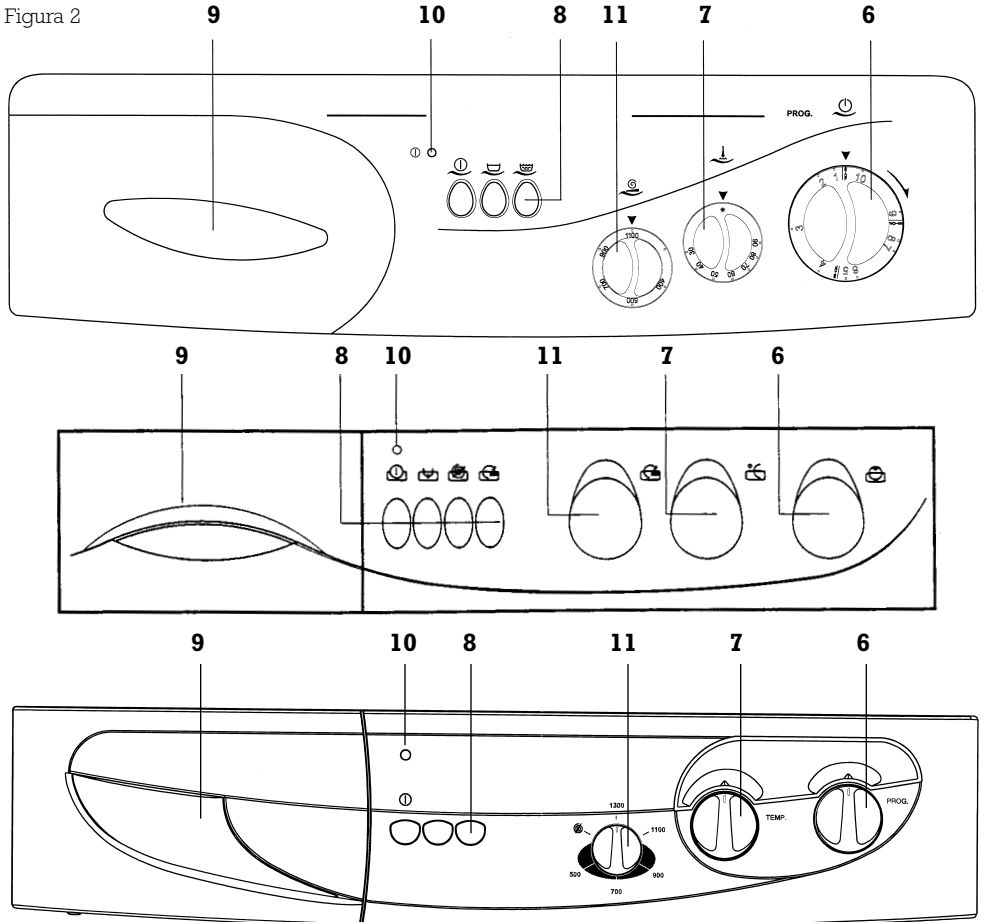



Figura 4

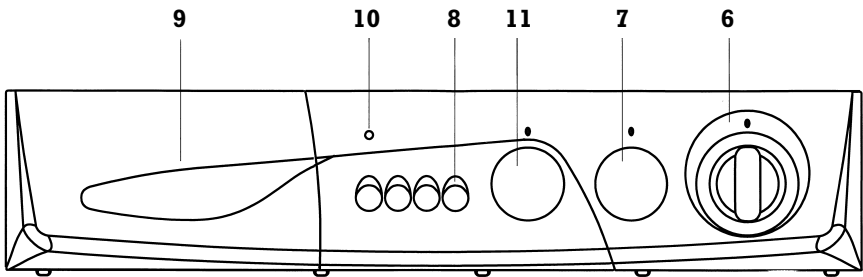
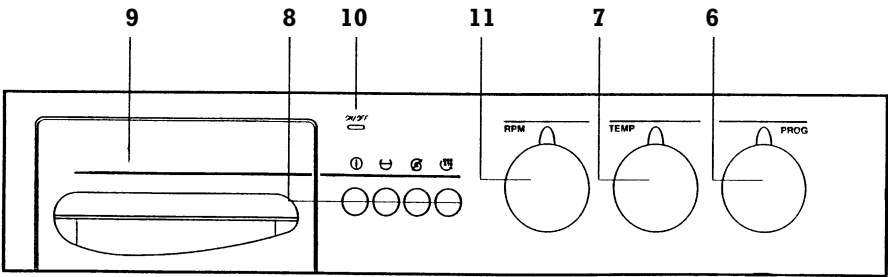
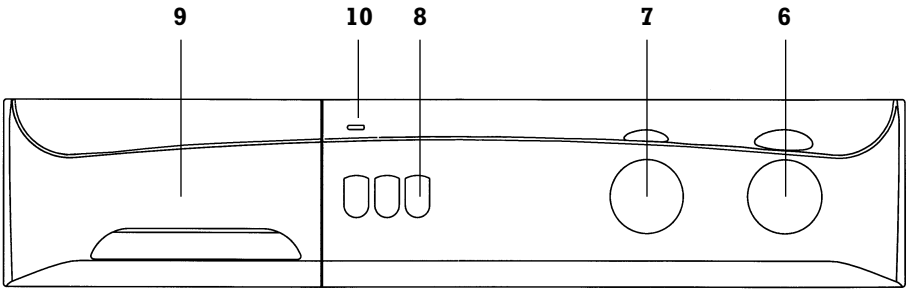
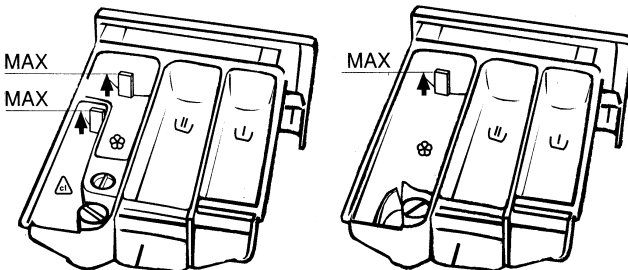

Figura 5

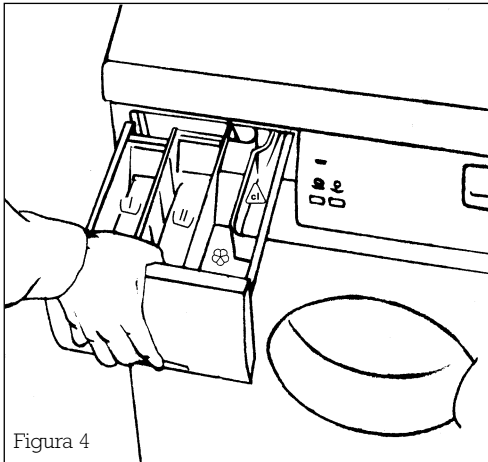

Detalle C

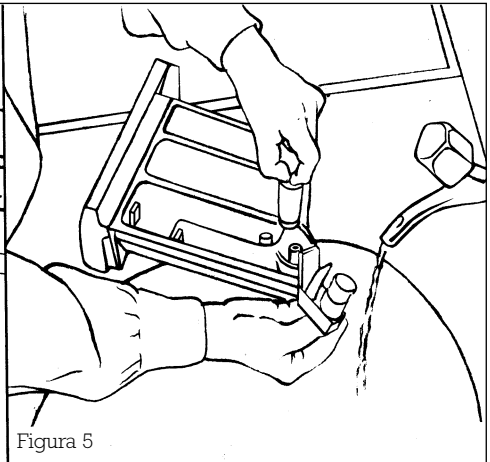
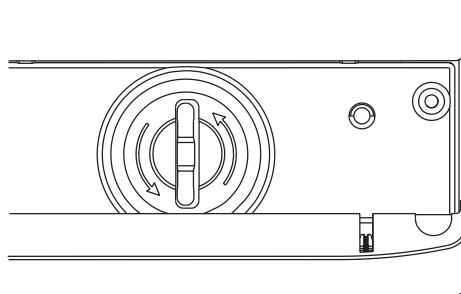
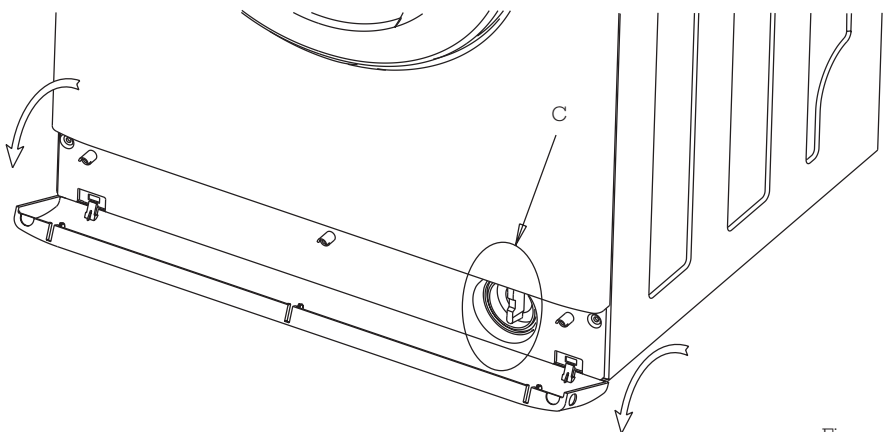

Figura 6